

# HSF

**NOTES:**

Rated Current:9.0AMP  
 Contact Resistance:30mΩ max  
 Withstand Voltage:1500V AC/minute  
 Insulation Resistance:1000MΩ min  
 Operation Temperature:-25℃ to +85℃

Contact Material:Brass  
 Contact plating:Au Or Sn Over Ni  
 Insulator Material:PA66 Or PA46

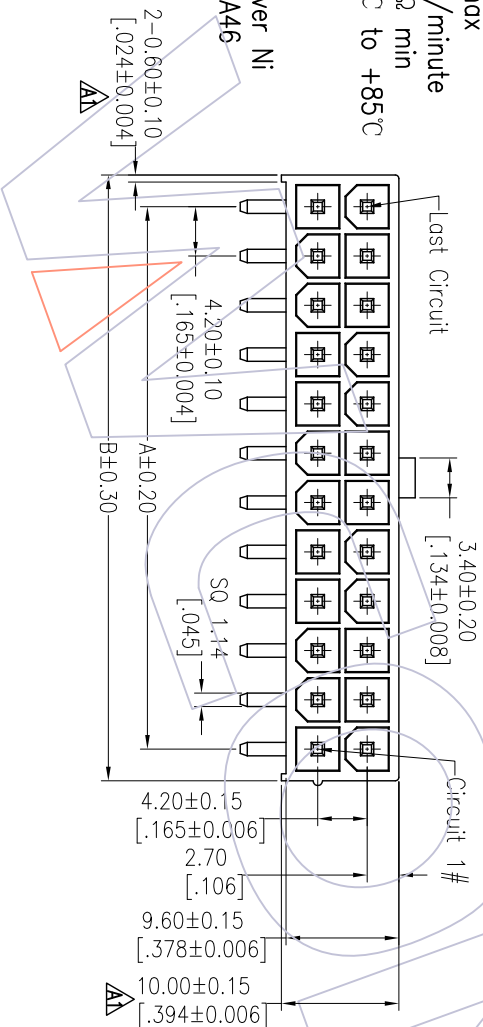

Recommended P.C.B Layout(Top Side)  
 (PCB BOARD TOLERANCE±0.05)

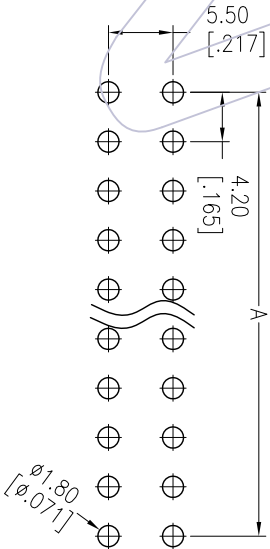

## Ordering Information

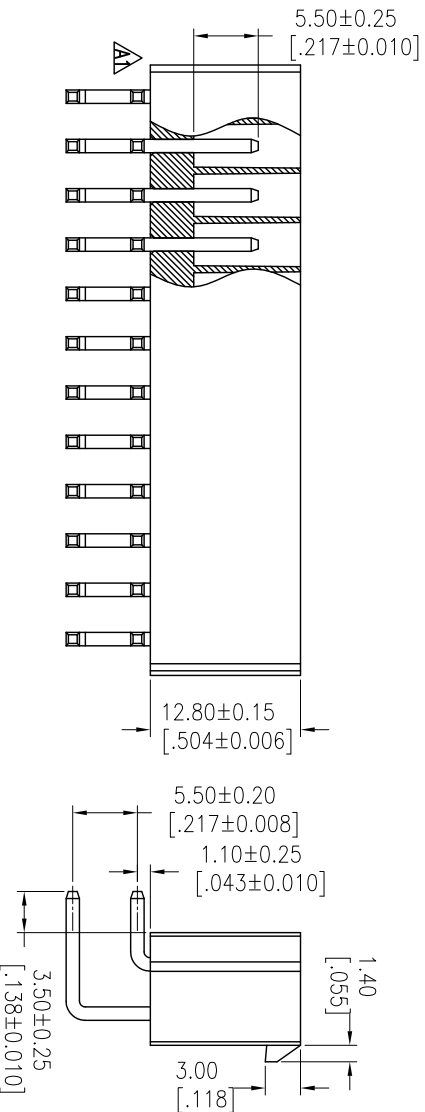
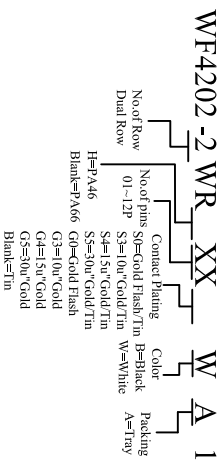

Specification & Ordering Information:

Circuit	Part No.	Dimension		Pcs /Tray
		A	B	
2x01	WF4202-2WR01WA1	---	5.40	410
2x02	WF4202-2WR02WA1	4.20	9.60	230
2x03	WF4202-2WR03WA1	8.40	13.80	160
2x04	WF4202-2WR04WA1	12.60	18.00	130
2x05	WF4202-2WR05WA1	16.80	22.20	100
2x06	WF4202-2WR06WA1	21.00	26.40	80
2x07	WF4202-2WR07WA1	25.20	30.60	70
2x08	WF4202-2WR08WA1	29.40	34.80	60
2x09	WF4202-2WR09WA1	33.60	39.00	60
2x10	WF4202-2WR10WA1	37.80	43.20	50
2x11	WF4202-2WR11WA1	42.00	47.40	50
2x12	WF4202-2WR12WA1	46.20	51.60	40

REV	DATE	MODIFICATION DESCRIPTION	CHANGE	OPERATION		DRAW		SCALE		PART NO.	
				X.X	±0.40	JHuang	DATE	mm	SEE TAB	TITLE:	WITHOUT POST
A1	2013/05/22	MODIFY THE DRAWING	---	X.XX	±0.25	CHECK	DATE	A4	4.20 MINI FIT DUAL ROW 90°	Customer NO.	
AO	2012/09/19	NEW	---	X.XXX	±0.15	APPROVE	DATE	1/2			
1				Angle	± 3'			PROJ.			

# WCON

WCON-Dongguan  
 Tel: +86 769 85358920  
 Fax: +86 769 85358915  
 E-mail: sales@wcon.com

WCON-Kunshan  
 Tel: +86 512 57468408  
 Fax: +86 512 57468468  
 E-mail: sales@wcon.com

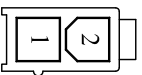

2x01P

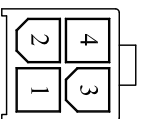

2x02P

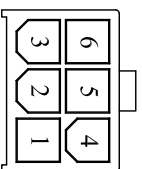

2x03P

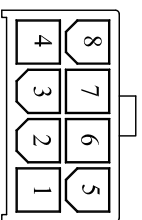

2x04P

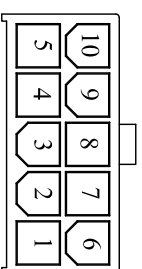

2x05P

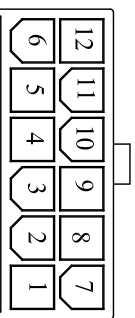

2x06P

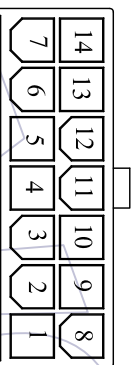

2x07P

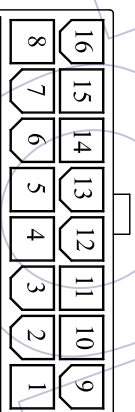

2x08P

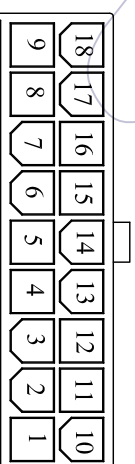

2x09P

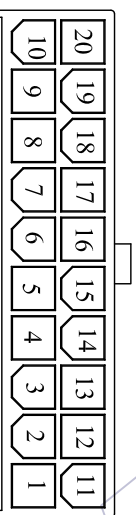

2x10P

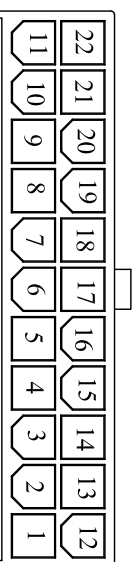

2x11P

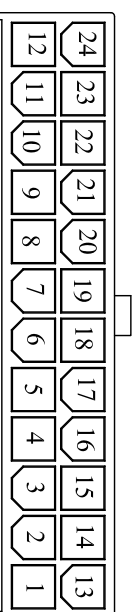

2x12P

OPERATION		DRAW		DATE		SCALE		FIT		PART NO.	
X.X	±0.40	JYhuang		2013/05/22		mm		SEE TAB	TITLE: 4.20 MINI FIT DUAL ROW 90° WITHOUT POST		
X.XX	±0.25	CHECK		DATE		A4			Customer NO.		
X.XXX	±0.15			DATE		2/2		WCON-Dongguan			
Angle	± 3'	APPROVE		DATE				WCON-Kunshan			
DIM	TOL			PROJ.				Tel: +86 769 85358920			
								Fax: +86 769 85358915			
								E-mail: sales@wcon.com			
								Tel: +86 512 57468408			
								Fax: +86 512 57468468			
								E-mail: sales@wcon.com			



WCON-Dongguan  
 Http: www.wcon.com  
 WCON-Kunshan  
 Tel: +86 769 85358920  
 Fax: +86 769 85358915  
 E-mail: sales@wcon.com